



TACT SWITCH

P/N: TSW10114-H

WATERPROOF



SPECIFICATIONS

Function: Momentary action
 Contact Arrangement: SPST, Normally Open
 Termination: THD version

Mechanical

Actuation Force: 230±70grams
 Life Expectancy: 100K Operations

Electrical

Contact Rating: 50mA @ 12V DC
 Dielectric Strength: 250V AC for 1minute
 Contact Resistance: 50mΩ Max.
 Insulation Resistance: 100MΩ Min.
 Travel: 0.30±0.1mm

Environmental

Operating Temperature: -25~+70°C
 Relative Humidity: (40°C) ≤95%

Materials

- 9.Barcket: Stainless steel
- 8.cover: Black GP.PA66
- 7.stem: Black GP.PC
- 6.washer: rubber
- 5.membrane: PIF membrane
- 4.inner stem: Black GP.PA66
- 3.Contact: copper with Silver cladding
- 2.Holder: Black GP.PA66
- 1.Terminal: Copper with Silver Cladding

Packaging

Bulk Package: Plastic bag
 Inner Package: Carton
 Outer Package: Carton

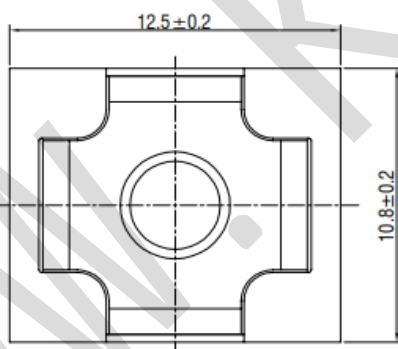
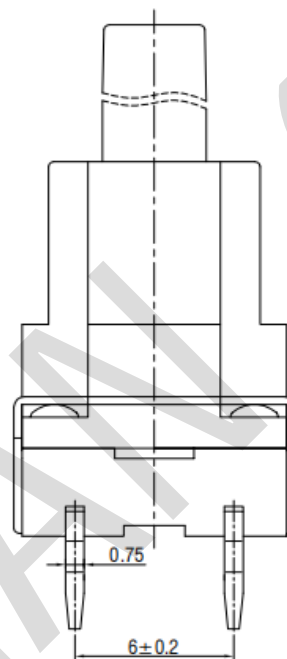
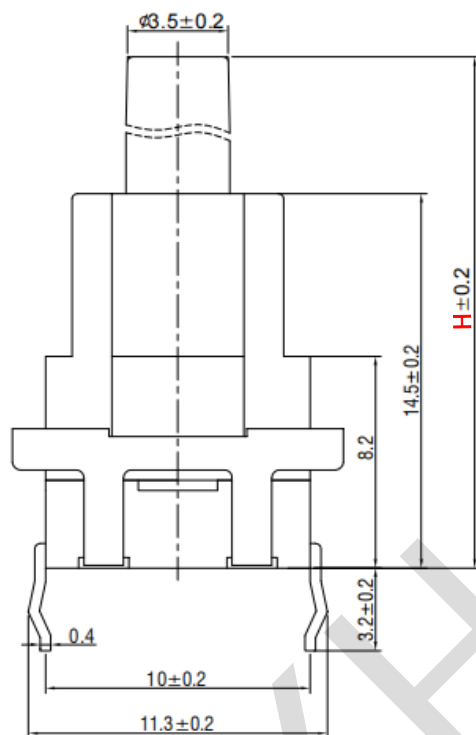

CIRCUIT DIAGRAM

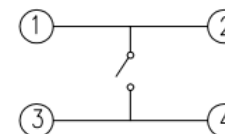

P.C.B. LAYOUT

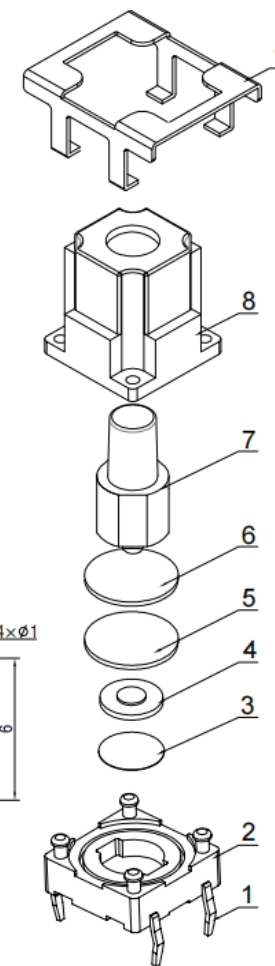
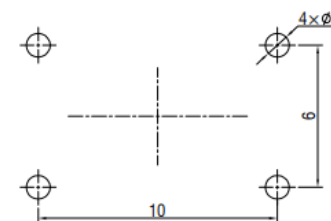

H	18.1	18.5	20.3	23.2	25.8	29
---	------	------	------	------	------	----



KANGHONG ELECTRONIC

VERSION

KH14FE22E

PROJECTION

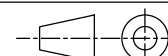

Dimensions are shown:mm(inches)

SCALE

4:1

SIZE

A4

2016.01.22

DESIGN

YUDA AO

DRAWN

ZHIJIE LU

APPROVAL

JUNHUI XU