

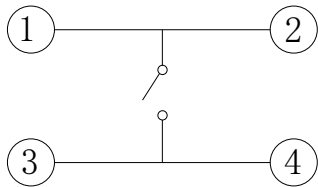

Switch drawings

Number Description

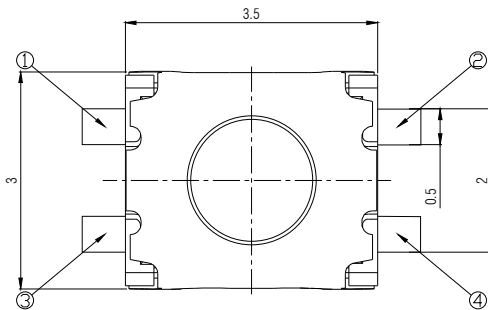
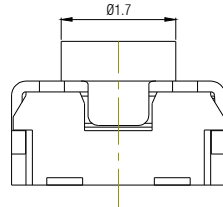
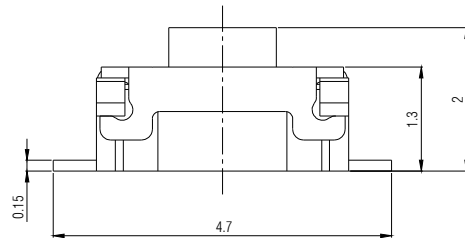

CIRCUIT DIAGRAM

Note: Unmarked tolerances for linear dimensions shall be in accordance with GB/T1804 level m.

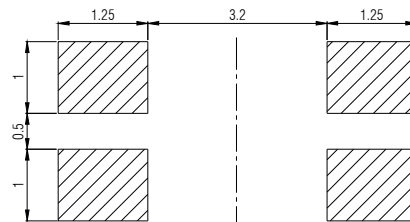

P.C.B. LAYOUT

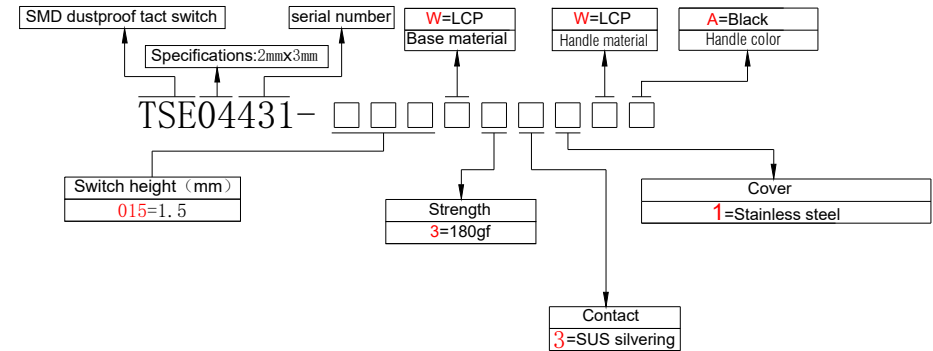

SPECIFICATIONS

Funtion:	Momentary action
Contact Arrangement:	SPST, Normally Open
Termination:	SMD version

Environmental

Operating Temperature:	-25~+70°C
Relative Humidity:	(40°C) ≤95%

Electrical

Contact Rating:	50mA 12V DC
Dielectric Strength:	250VAC /1min
Contact Resistance:	100m Ω Max.
Insulation Resistance:	100M Ω Min.
Travel:	0.2 ± 0.1mm
Sealing:	IP6X

Mechanical

Actuation Force:	220gf
Life Expectancy:	100K

Materials

6.Stem:	Black PPA
5.Cover:	Stainless steel
4.Waterproof membrane:	Polyimide
3.Spring:	Stainless steel covered with silver
2.Holder:	Black LCP
1.Terminal:	Phosphor copper plated with silver

